



Model: **16-132L** Item #: _____ Date: _____

Project: _____ Qty: _____ Approved By: _____

Single Hole Deck Mount Remote 8" Swing Spout

Royal Series

DESCRIPTION

- Single Hole, Deck Mount Remote 8" Swing Spout, Polished Chrome Finish, 1.8 GPM Female Aerator Installed



STANDARD FEATURES

- Controlled by foot or knee valve
- Durable full range swing spout with double o-ring construction
- Warranty: 3 years

SPECIFICATIONS

Water Inlet	1/2" NPS Male
Temp. Range	40°F - 180°F
Pressure	20-120 PSI
Rough In	7/8" Round Hole
Flow Rate	1.8 GPM
Material	Solid Brass
Finish	Polished Chrome
Weight	2 lbs.

PRODUCT COMPLIANCE

- NSF-61 & NSF/ANSI 372
- ASME A112.18.1-2011/CSA B125.1-11 & NSF/ANSI 372
- Meets ANSI A117.1 (ADA)
- Massachusetts Approved
- CEC Approved

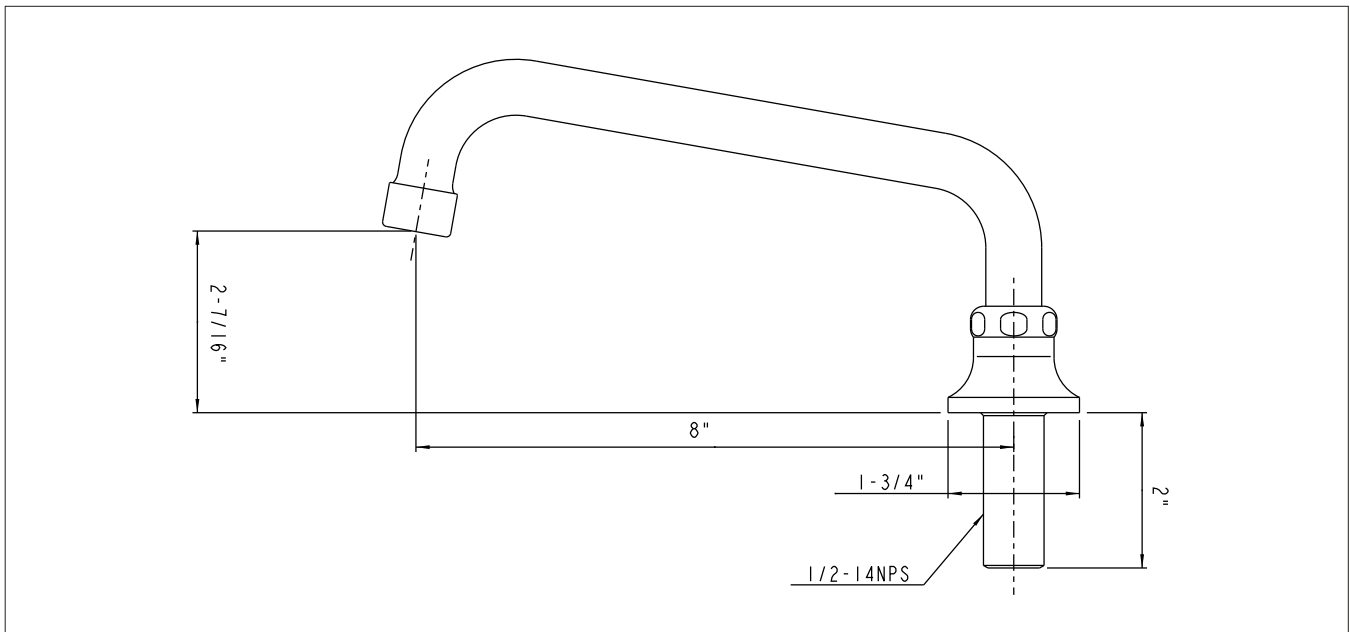

WARNING: Plumbing connections should be made by qualified personnel who will observe all applicable plumbing, sanitary and safety codes.
California Proposition 65 Warning