



MASTERTAP™
BEVERAGE DISPENSING SYSTEMS

Keg Capacity Guide

For Direct Draw Coolers

Models DB24, DB36, DB52, DB60, DB72, DB84, DB108



Intertek

Conforms TO UL Std 471
Certified to CSA Std C22.2 #120

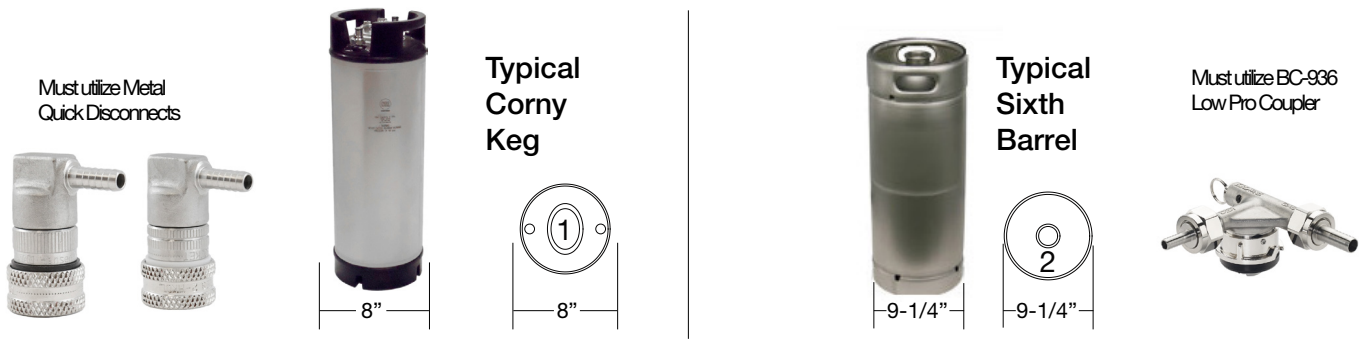

Single Door Units

Models beginning with DB24

NOTE: DB24 models have narrow doors and cannot fit Half Barrels

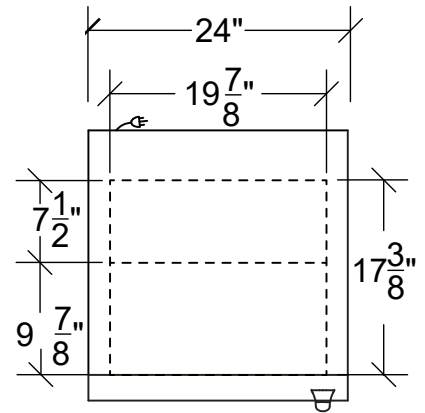
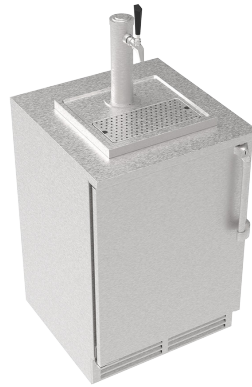

17-3/8" x 19-7/8" Inside Cabinet

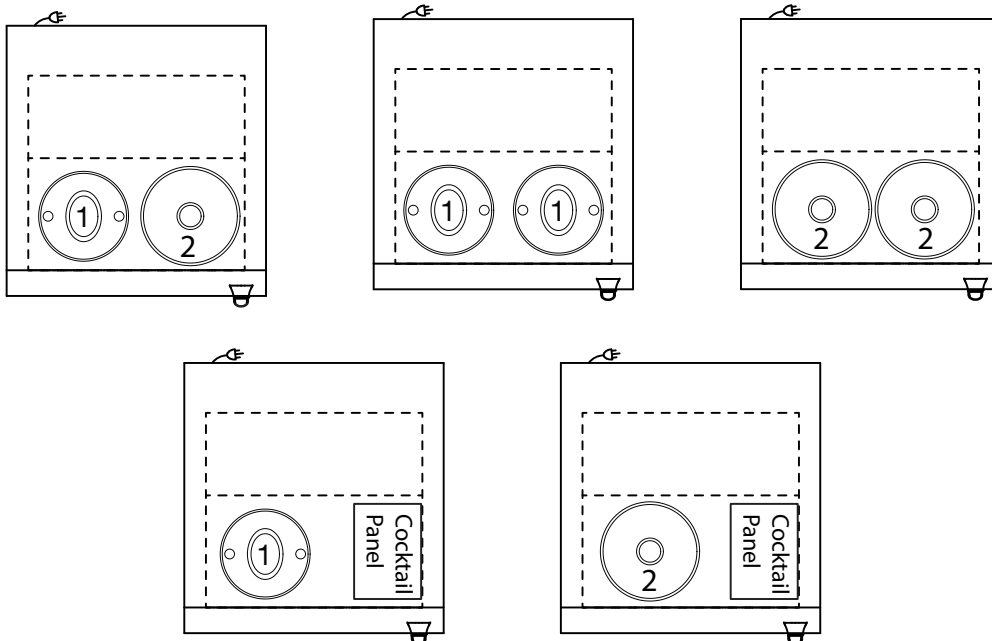



Single Door Units

Models beginning with DB36

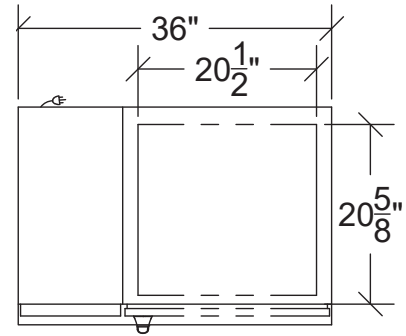

20" x 20-5/8" Inside Cabinet

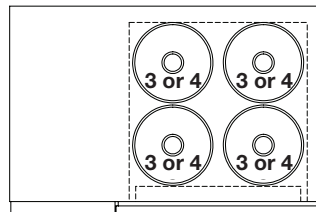
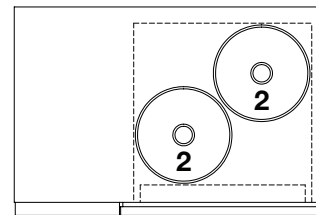
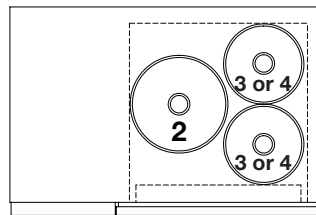
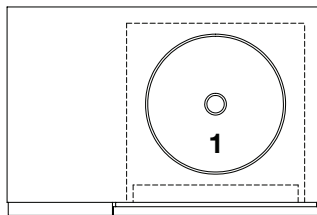



Two Door Units

Models beginning with DB52

NOTE: DB52 models have narrow doors and cannot fit Half Barrels

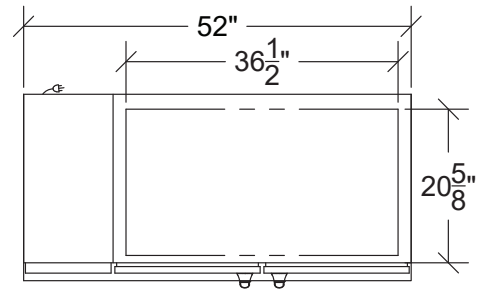

36-1/2" x 20-5/8" Inside Cabinet

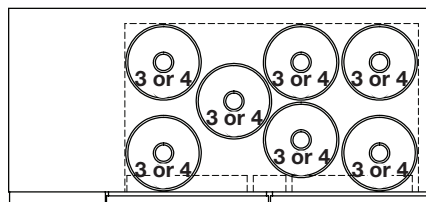
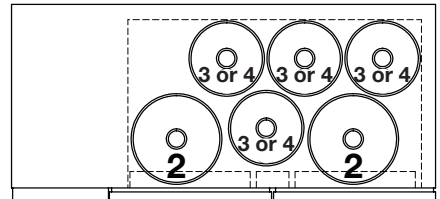
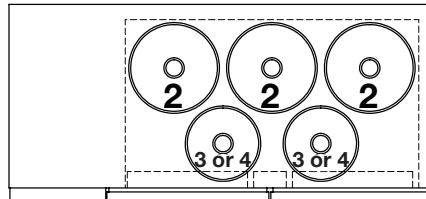
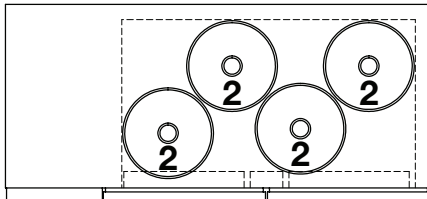



Two Door Units

Models beginning with DB60

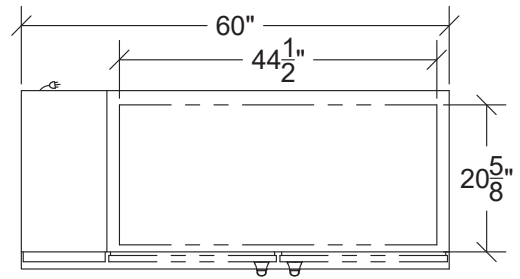

44-1/2" x 20-5/8" Inside Cabinet

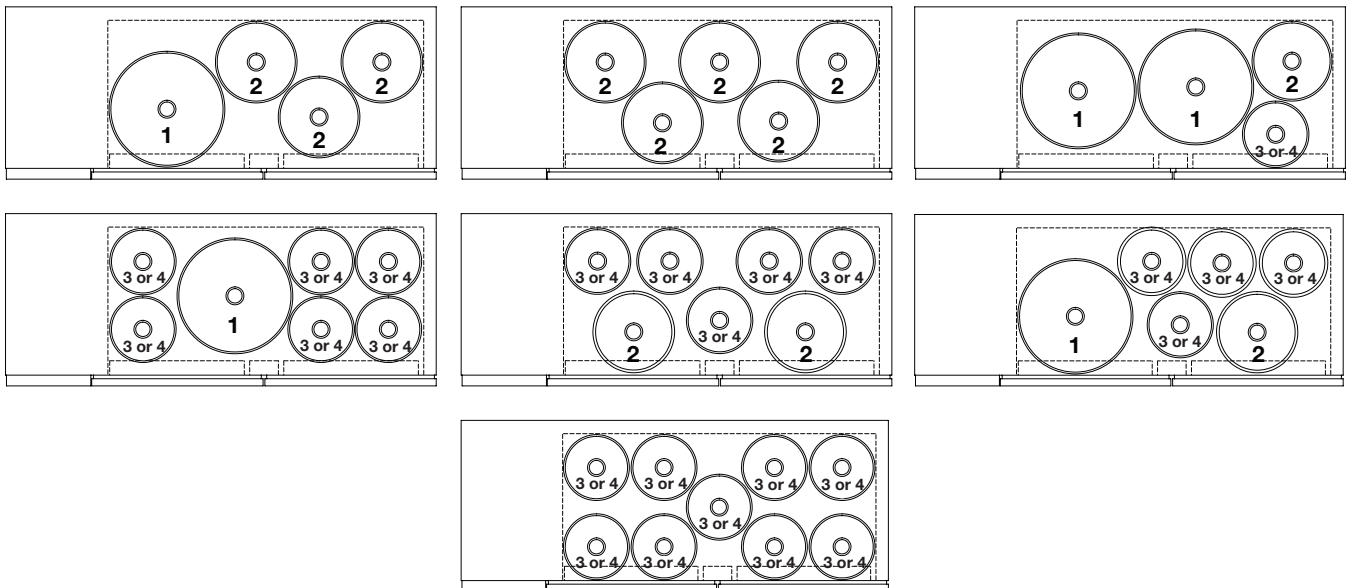



Typical Half Barrel

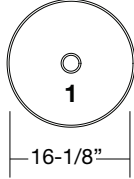

Typical Quarter Barrel

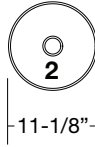

Typical Sixth Barrel



Typical Corny Keg

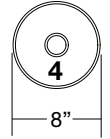

Two Door Units

Models beginning with DB72

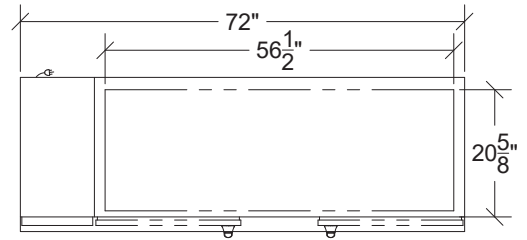

56-1/2" x 20-5/8" Inside Cabinet

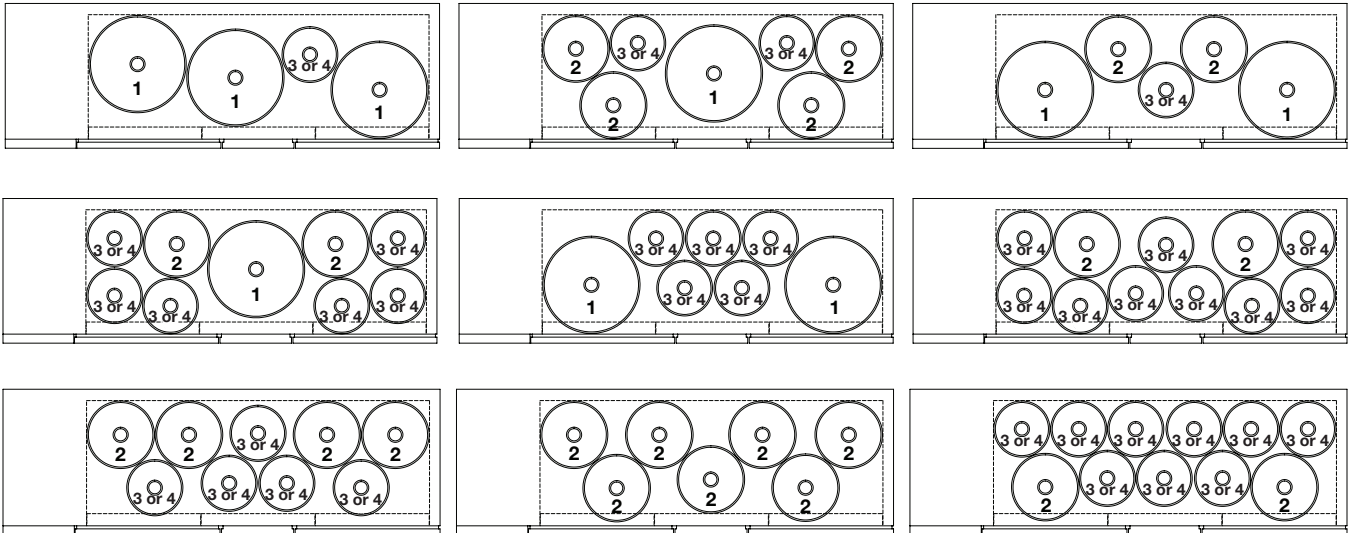



Three Door Units

Models beginning with DB84

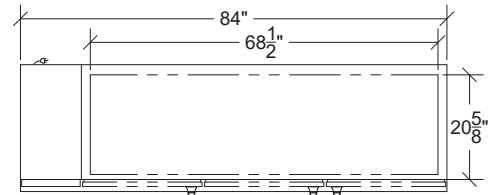

68-1/2" x 20-5/8" Inside Cabinet

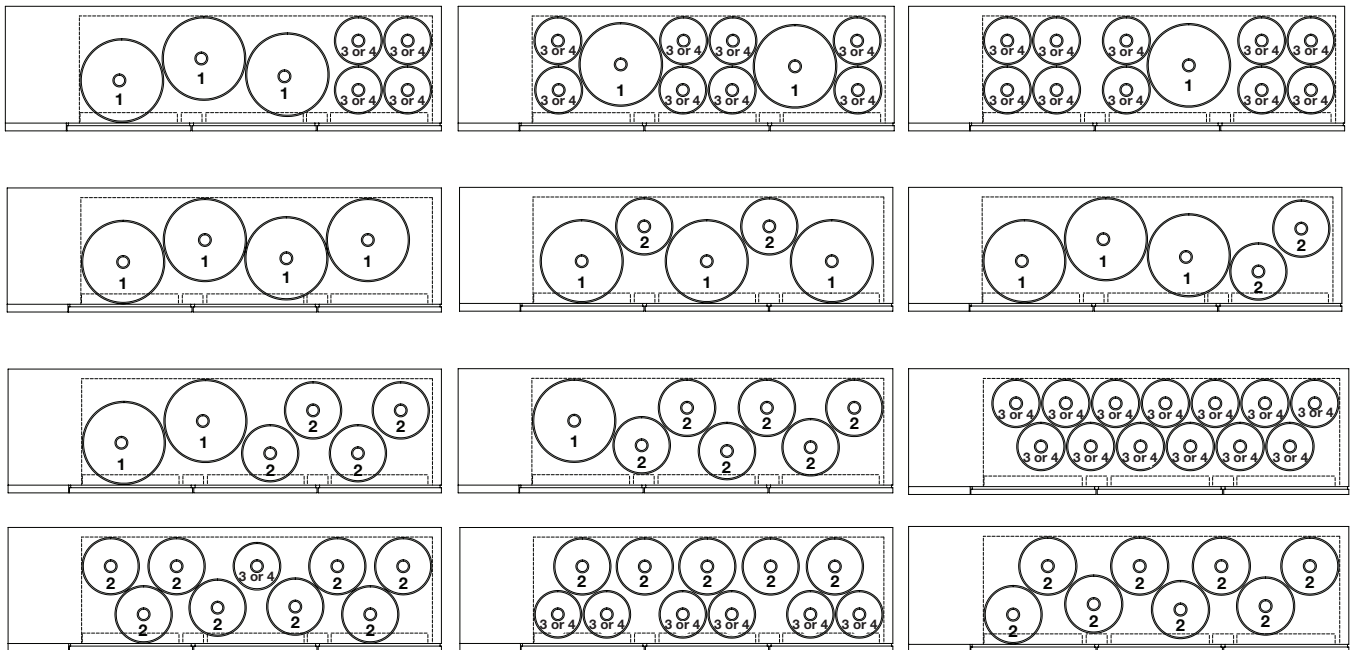

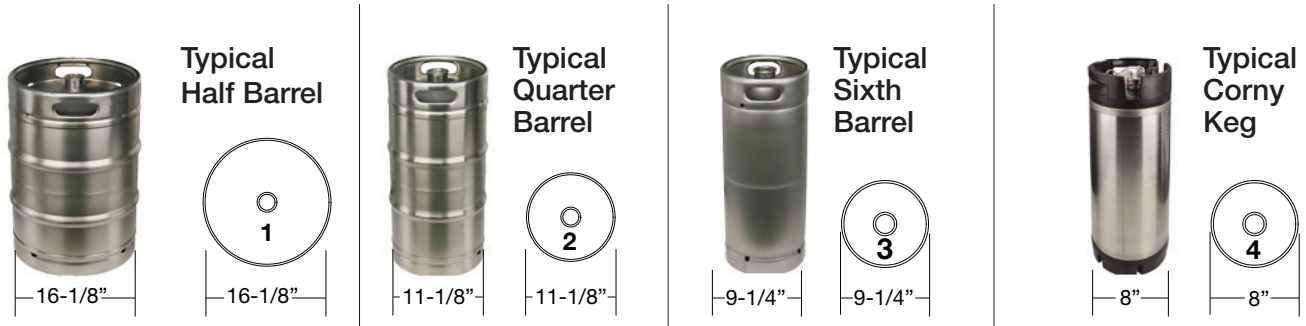

Four Door Units

Models beginning with DB108

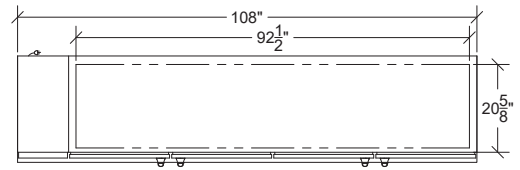

92-1/2" x 20-5/8" Inside Cabinet

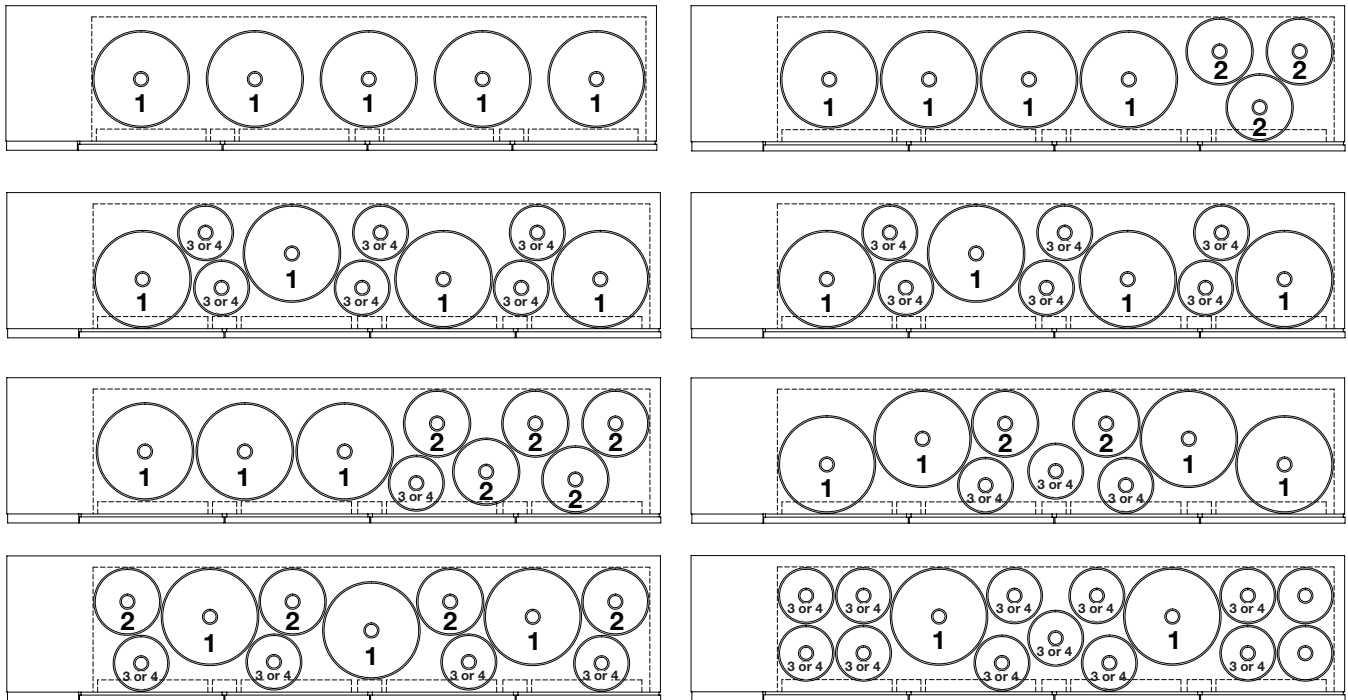

More DB108 configurations on the next page >



Four Door Units

(continued)

Models beginning with DB108

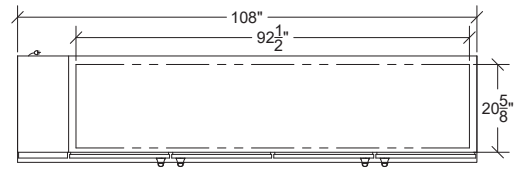

92-1/2" x 20-5/8" Inside Cabinet

